

**Advin**

WAIT.....



# Intelligent Transport Systems

[mattieu.nuijten@advin.nl](mailto:mattieu.nuijten@advin.nl)

**Advin**

# I have a Dream...

## "Paperless office"



Advin



# Advin

## ...We are working on IT...



Communicerende auto's elimineren invloed bestuurder

# Beter bumperkleven

Communicatie tussen auto's kan fileleed verzachten, de uitstoot van CO<sub>2</sub> verkleinen en de veiligheid op de weg vergroten. Deze maand demonstreerden tien teams op de A270 bij Helmond tijdens de Grand Cooperative Driving Challenge hun concepten. Hoevel de

...koppeling tussen com...  
...plex is, kan coö...  
...ledig handsfree.'

### » Een rijdend hackersparadijs

Ultrasonische parkeren:...  
Satellietnavigatie en radio...  
Schaaktoetsing:...  
Alarms en veranderingen:...  
Vereniging:...  
Adaptieve vering:...  
Autonomie:...

Centraal bestuurscomputer

1.2 F22 Jaguar  
1.5 F18 JFJ  
0.7 F17  
100 F18

Halelujah, roept de hacker: de auto wordt een iPad op wielen

Amerikaanse onderzoekers hebben laten zien dat ze op afstand de elektronica in een auto kunnen aanpassen. Dat is de prijs die we betalen voor zuinigere motoren en meer luxe. Door Peter van Amelsvoort

Of maar ik, nou weg naar na...  
Van de onderzoekers is de...  
De processoren die elk een...  
...de auto wordt een iPad op wielen...  
Amerikaanse onderzoekers hebben laten zien dat ze op afstand de elektronica in een auto kunnen aanpassen. Dat is de prijs die we betalen voor zuinigere motoren en meer luxe. Door Peter van Amelsvoort

### VERBODEN VOERTUIG

...de auto wordt een iPad op wielen...  
Amerikaanse onderzoekers hebben laten zien dat ze op afstand de elektronica in een auto kunnen aanpassen. Dat is de prijs die we betalen voor zuinigere motoren en meer luxe. Door Peter van Amelsvoort

### Veiliger rijden met slimme auto

Auto's worden mobiele netwerken die anticiperen op andere weggebruikers. Hopelijk nemen files en ongelukken daardoor af.

...de auto wordt een iPad op wielen...  
Amerikaanse onderzoekers hebben laten zien dat ze op afstand de elektronica in een auto kunnen aanpassen. Dat is de prijs die we betalen voor zuinigere motoren en meer luxe. Door Peter van Amelsvoort

# Advin

## ...“paperless”?

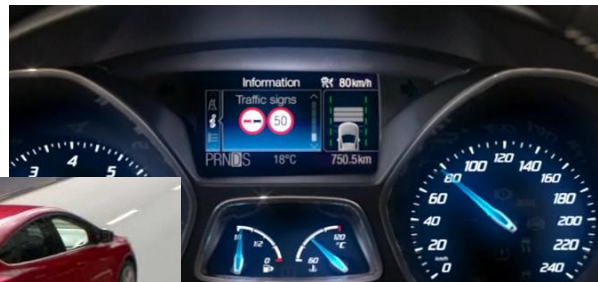

# Advin

# “Beter Benut”

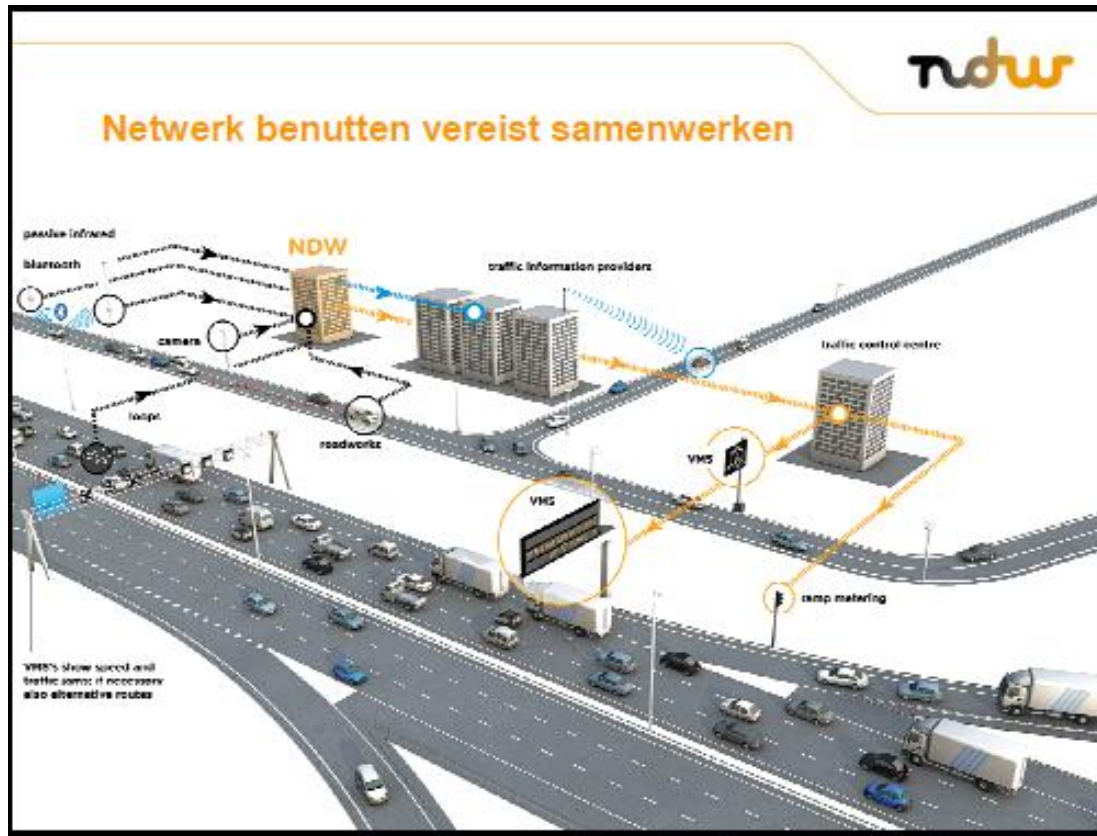

Marja van Strien  
DVM-congres 12 mei 2011

# Advin

# Sharing data to...?



Input

Production

Output

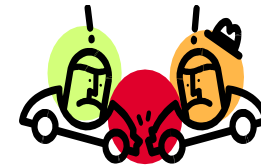
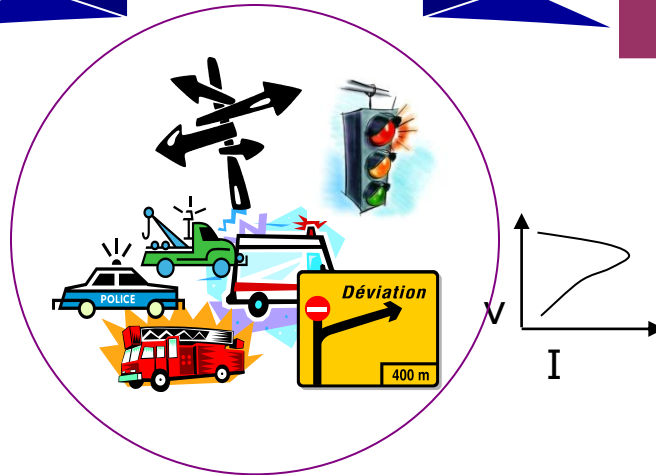
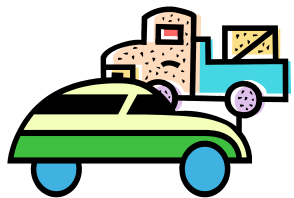

# Advin

# Modeling Traffic



Input

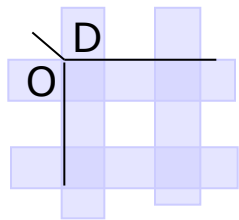

Characters

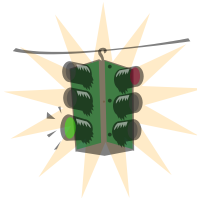
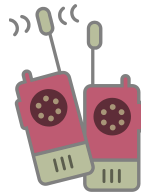

Scale

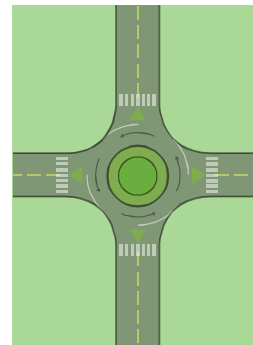

Result

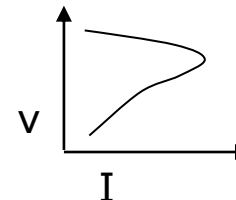
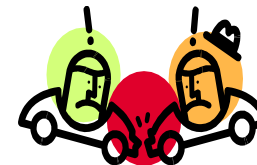

**Advin**

Looking for...?



Advin

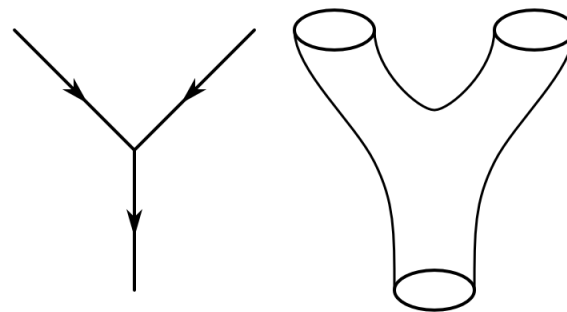
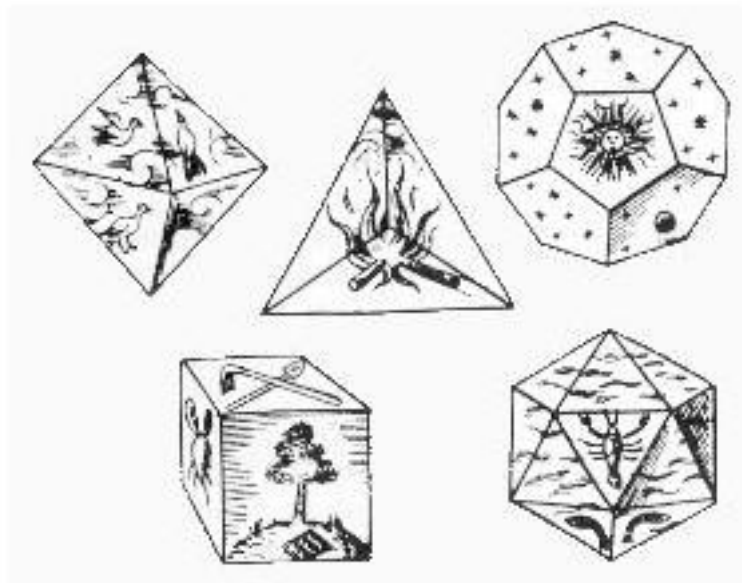

ADVISEURS EN INGENIEURS



# Advin

# Control



Advin

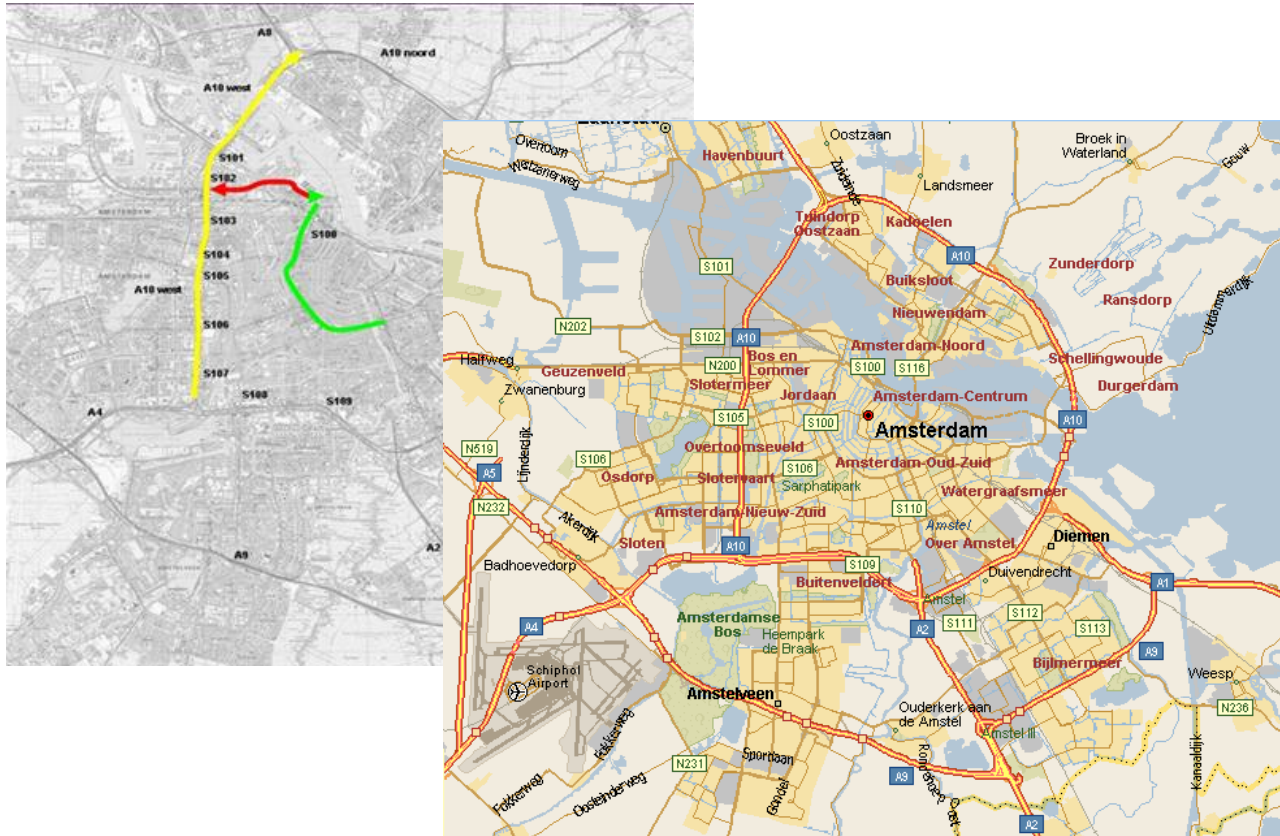

# Advin

# Network design

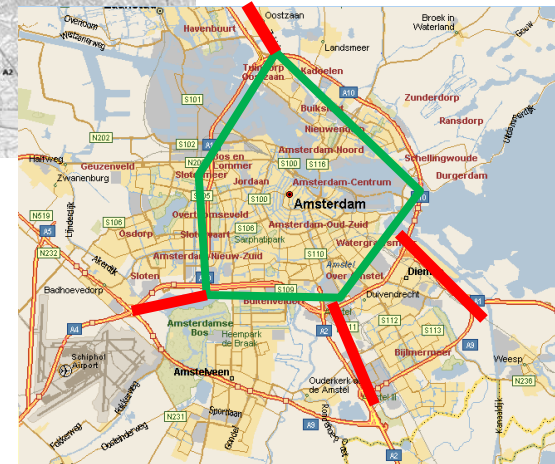
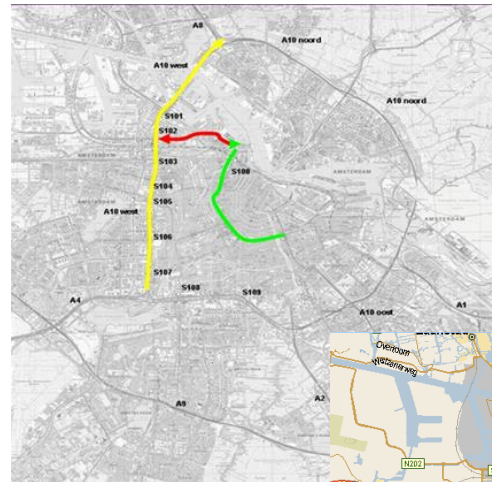
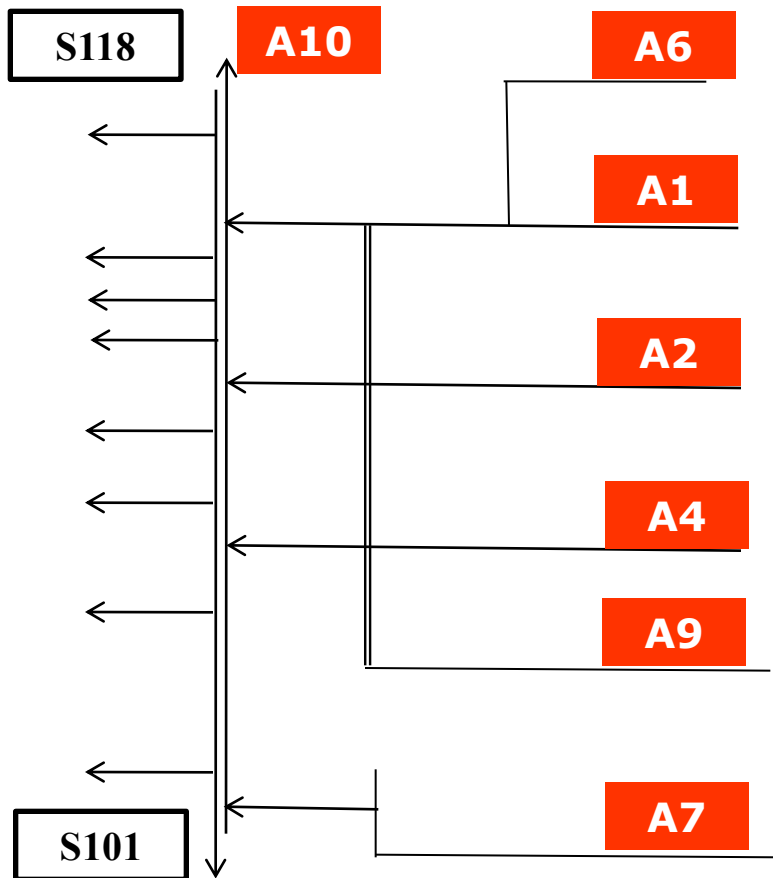

# Advin

# Network design

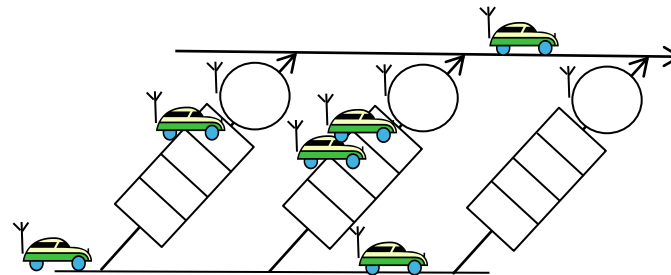
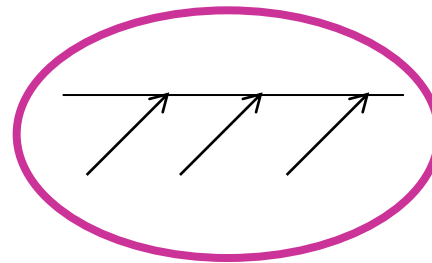
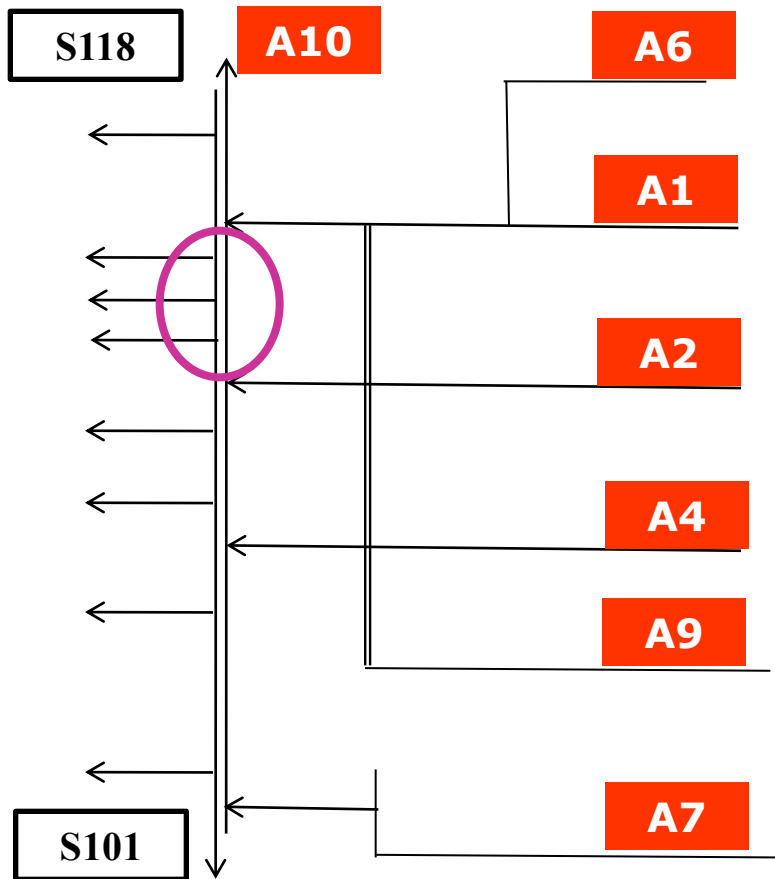

# Advin

# Who's talking?



Advin

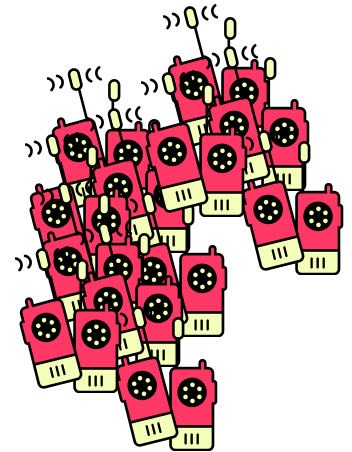
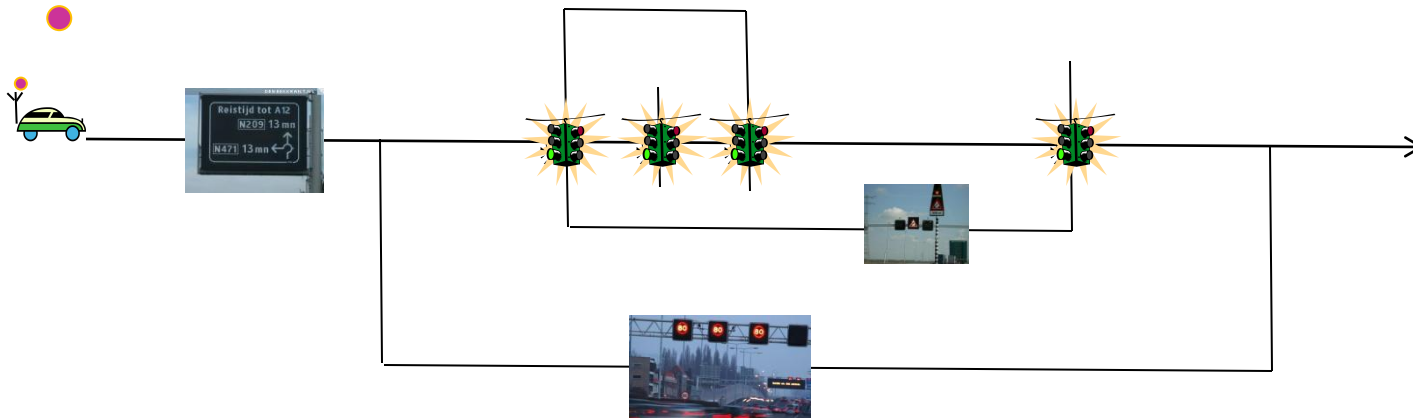
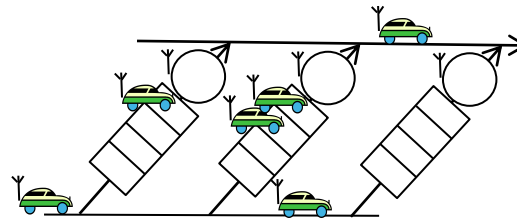

# Advin

# "Weather Forecast"

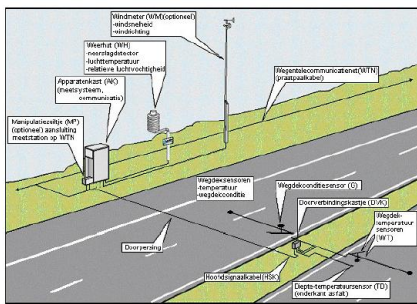

**Today**



**Tomorrow**

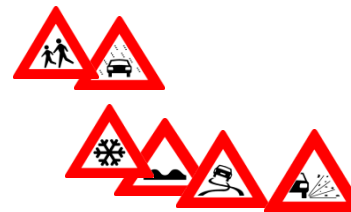

**After tomorrow**



Advin

# Advin

# So.....



We will be waiting, real time or "Microsoft"-time. Traffic lights (road side equipment) will be there. The most intelligence is on bikes.

**[mattieu.nuijten@advin.nl](mailto:mattieu.nuijten@advin.nl)**

**Advin**

Vragen, discussie, contact



Advin

[mattieu.nuijten@advin.nl](mailto:mattieu.nuijten@advin.nl)